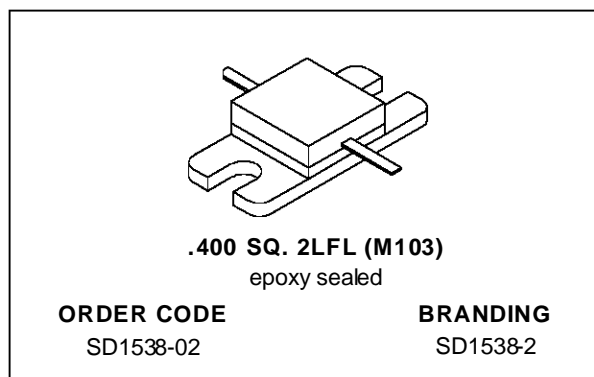
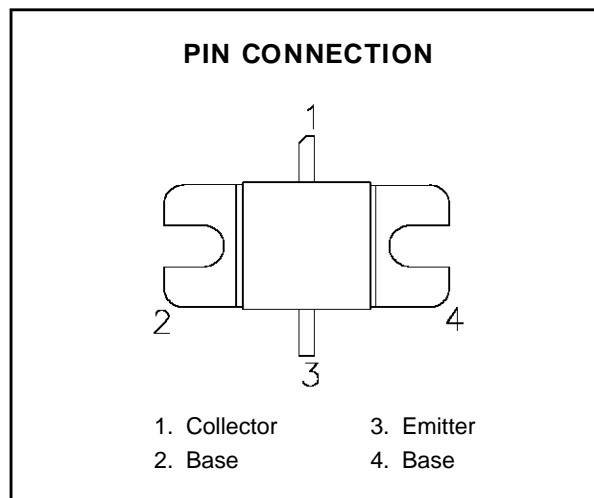

**RF & MICROWAVE TRANSISTORS
AVIONICS APPLICATIONS**

- DESIGNED FOR HIGH POWER PULSED IFF, DME, TACAN APPLICATIONS
- 200 WATTS (typ.) IFF 1030 - 1090 MHz
- 150 WATTS (min.) DME 1025 - 1150 MHz
- 140 WATTS (typ.) TACAN 960 - 1215 MHz
- 7.8 dB MIN. GAIN
- REFRACTORY GOLD METALLIZATION
- EMITTER BALLASTING AND LOW THERMAL RESISTANCE FOR RELIABILITY AND RUGGEDNESS
- 30:1 LOAD VSWR CAPABILITY AT SPECIFIED OPERATING CONDITIONS
- INPUT/OUTPUT MATCHED, COMMON BASE CONFIGURATION

DESCRIPTION

The SD1538-02 is a gold metallized silicon, NPN power transistor designed for applications requiring high peak power and low duty cycles such as IFF, DME and TACAN. The SD1538-02 is packaged in a metal/ceramic package with internal input/output matching resulting in improved broadband performance and a low thermal resistance.

ABSOLUTE MAXIMUM RATINGS ($T_{case} = 25^{\circ}C$)

Symbol	Parameter	Value	Unit
V_{CBO}	Collector-Base Voltage	65	V
V_{CES}	Collector-Emitter Voltage	65	V
V_{EBO}	Emitter-Base Voltage	3.5	V
I_C	Device Current	11.0	A
P_{DISS}	Power Dissipation	583	W
T_J	Junction Temperature	+200	$^{\circ}C$
T_{STG}	Storage Temperature	- 65 to +150	$^{\circ}C$

THERMAL DATA

$R_{TH(j-c)}$	Junction-Case Thermal Resistance	0.30	$^{\circ}C/W$
---------------	----------------------------------	------	---------------

SD1538-02

ELECTRICAL SPECIFICATIONS (T_{case} = 25°C)

STATIC

Symbol	Test Conditions		Value			Unit
			Min.	Typ.	Max.	
BV _{CBO}	I _C = 10mA	I _E = 0mA	65	—	—	V
BV _{CES}	I _C = 25mA	V _{BE} = 0V	65	—	—	V
BV _{EBO}	I _E = 5mA	I _C = 0mA	3.5	—	—	V
I _{CES}	V _{CE} = 50V	I _E = 0mA	—	—	10	mA
h _{FE}	V _{CE} = 5V	I _C = 300mA	5	—	—	—

DYNAMIC

Symbol	Test Conditions			Value			Unit
				Min.	Typ.	Max.	
P _{OUT}	f = 1025 — 1150MHz	P _{IN} = 25.0 W	V _{CE} = 50 V	150	—	—	W
G _p	f = 1025 — 1150MHz	P _{IN} = 25.0 W	V _{CE} = 50 V	7.8	—	—	dB

Note: Pulse Width = 10μSec, Duty Cycle = 1%
 This device is suitable for use under other pulse width/duty cycle conditions.
 Please contact the factory for specific applications assistance.

TYPICAL PERFORMANCE

POWER OUTPUT vs POWER INPUT

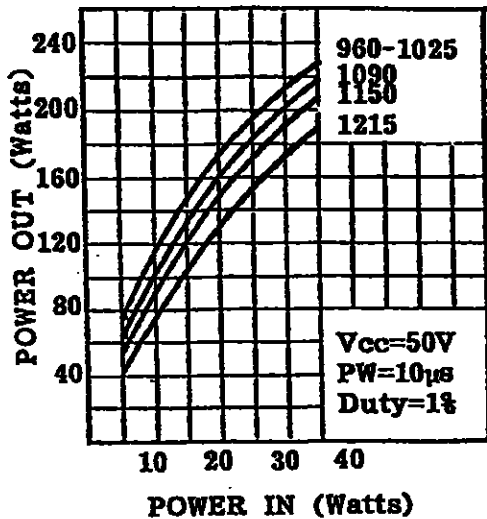

POWER OUTPUT vs FREQUENCY

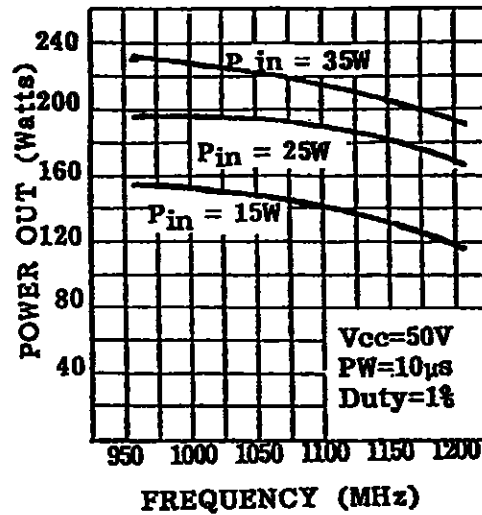

TYPICAL PERFORMANCE (cont'd)

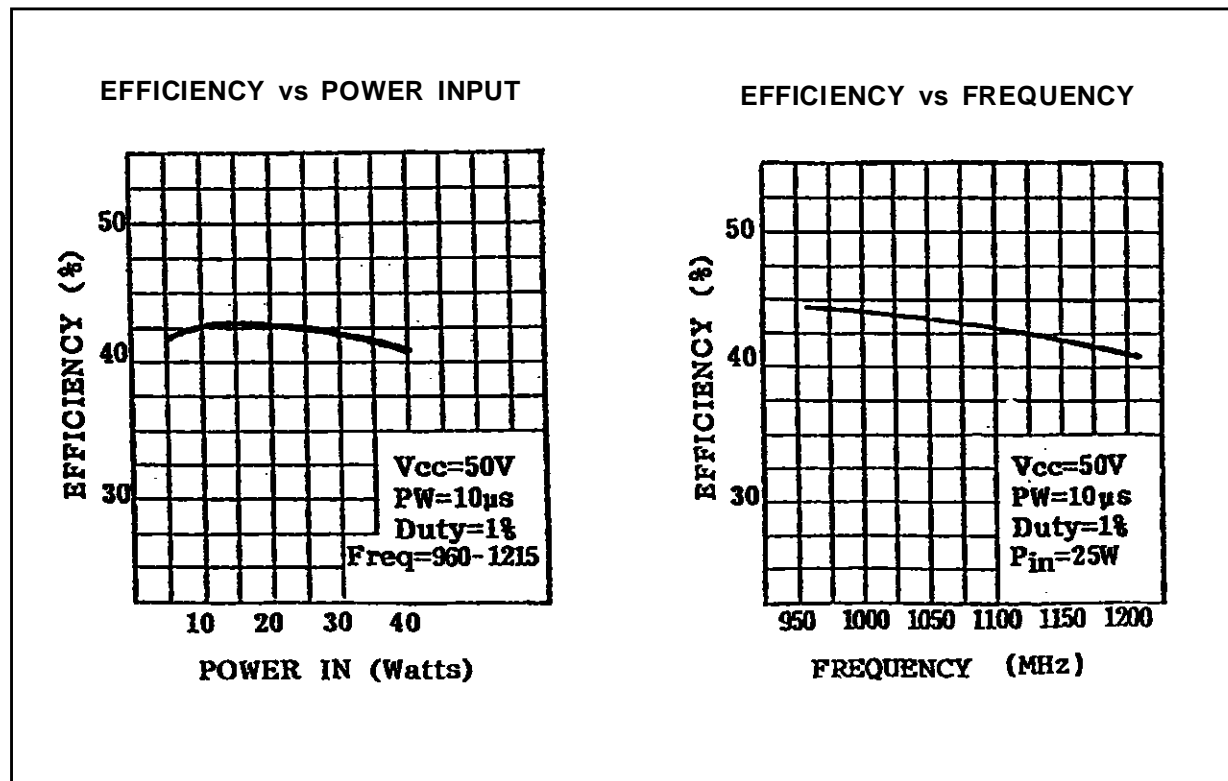

IMPEDANCE DATA

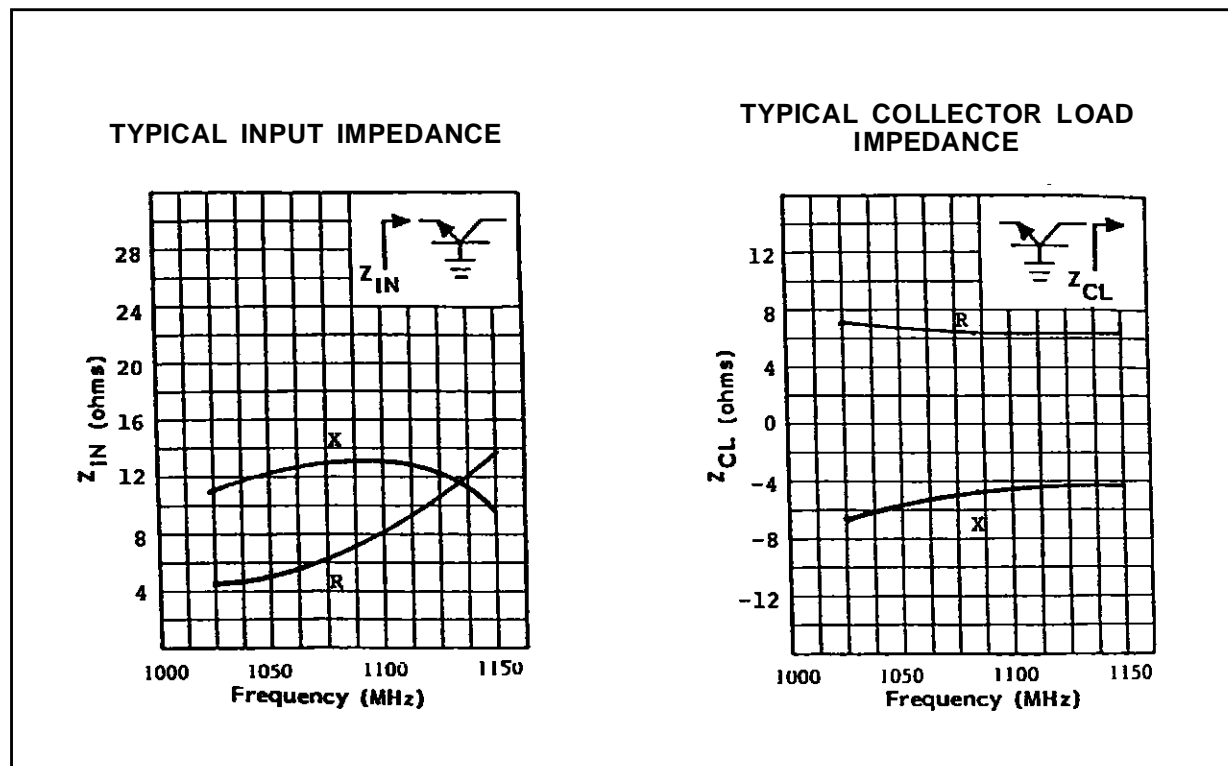

TEST CIRCUIT AND PC BOARD LAYOUT

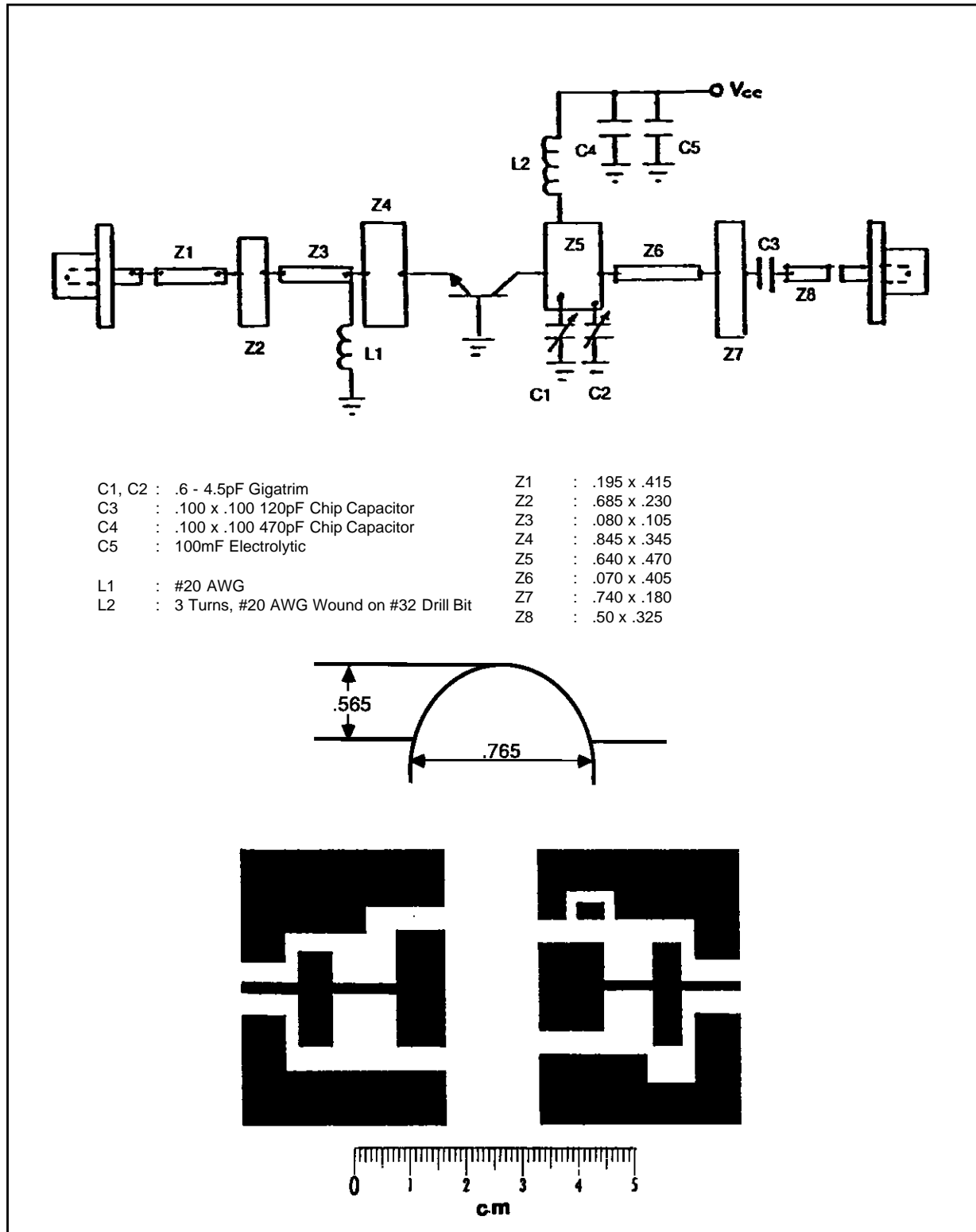

PACKAGE MECHANICAL DATA

Ref.: Dwg. No.12-0103

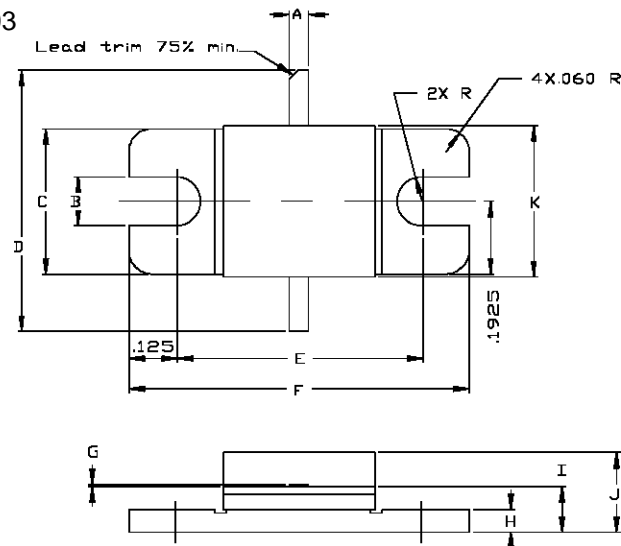

SGS-THOMSON MICROELECTRONICS		CONT'D			
	MINIMUM Inches/mm	MAXIMUM Inches/mm		MINIMUM Inches/mm	MAXIMUM Inches/mm
A	.045/1,14	.055/1,40	K	.390/9,91	.410/10,41
B	.130/3,30				
C	.380/ 9,65	.390/ 9,91			
D	.880/22,35	.920/23,37			
E	.645/16,38	.655/16,64			
F	.890/22,61	.910/23,11			
G	.002/0,05	.006/0,15			
H	.055/1,40	.065/1,65			
I	.110/2,79	.130/3,30			
J	.190/4,83	.215/5,46			

Information furnished is believed to be accurate and reliable. However, SGS-THOMSON Microelectronics assumes no responsibility for the consequences of use of such information nor for any infringement of patents or other rights of third parties which may result from its use. No license is granted by implication or otherwise under any patent or patent rights of SGS-THOMSON Microelectronics. Specifications mentioned in this publication are subject to change without notice. This publication supersedes and replaces all information previously supplied. SGS-THOMSON Microelectronics products are not authorized for use as critical components in life support devices or systems without express written approval of SGS-THOMSON Microelectronics.

© 1994 SGS-THOMSON Microelectronics - All Rights Reserved

SGS-THOMSON Microelectronics GROUP OF COMPANIES
 Australia - Brazil - France - Germany - Hong Kong - Italy - Japan - Korea - Malaysia - Malta - Morocco - The Netherlands -
 Singapore - Spain - Sweden - Switzerland - Taiwan - Thailand - United Kingdom - U.S.A